

M12 MALE 0° / MSUD VALVE PLUG FORM A 18MM

PUR 5X0.34 YELLOW, UL/CSA, drag ch 3m

Form A (18 mm) – M12, male straight

24 V DC $\pm 25\%$

LED (red/green)

for pressure switches

Further cable lengths on request.

Plastic housings with good resistance against chemicals and oils.

The resistance to aggressive media should be individually tested for your application. Further details on request.

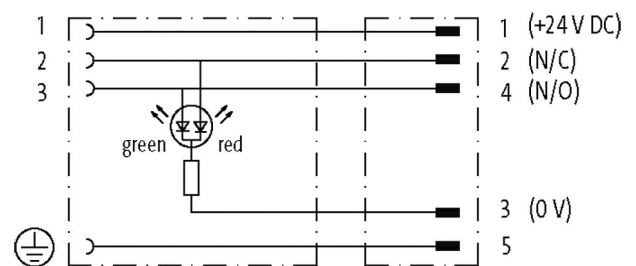
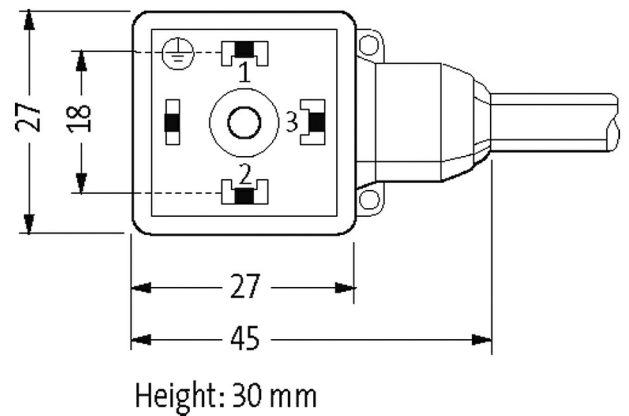
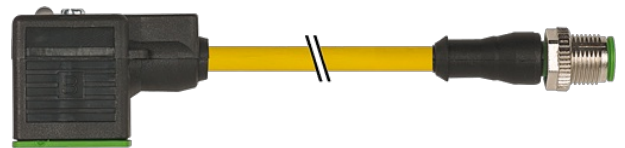
Illustration

Female

Male

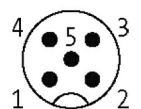
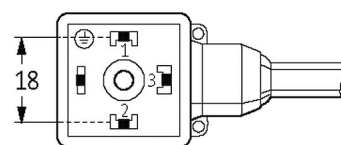

Product may differ from Image

Approvals

cCSAus

* only for products with UL/CSA approved cable

Cables	
No./diameter of wires	5 × 0.34 mm ²
Wire isolation	PP (br, wh, bl, bk, gnye)
C-track properties	10 Mio.
Material (jacket)	PUR (UL/CSA)
Outer Ø	4.8 mm ±5%
Bend radius (moving)	10× outer Ø
Temperature range (fixed)	-40...+80 °C
Temperature range (mobile)	-25...+80 °C
Cable identification	035
Cable Type	3 (PUR)
Approval (cable)	cURus (AWM-Style 20549/10493); CE conform
Cable weight [g/m]	41,80
Material (wire)	Cu wire, bare
Resistor (core)	max. 57 Ω/km (20 °C)
Single wire Ø (core)	0.1 mm
Construction (core)	42 × 0.1 mm (multi-strand wire class 6)
Diameter (core)	5 × 0.34 mm ²
AWG	similar to AWG 22
Material (wire isolation)	PP
Material property (wire isolation)	CFC-, halogen-, cadmium-, silicone- and lead-free
Shore hardness (wire isolation)	70 ±5 D
Wire-Ø incl. isolation	1.25 mm ±5%
Color/numbering of wires	br, bk, bl, wh, gnye longitudinally striped
Stranding combination	5 wires twisted around central filler
Shield	no
Material (jacket)	PUR
Material property (jacket)	CFC-, halogen-, cadmium-, silicone- and lead-free, matt, low-adhesion, machine easy to process, abrasion-resistant, hydrolysis and microbial resistant
Shore hardness (jacket)	90 ±5 A
Outer-Ø (jacket)	4.8 mm ±5%
Color (jacket)	yellow
chemical resistance	good resistance to oil, gasoline and chemicals (EN 60811-404)
thermal resistance	flame retardant UL 1581 VW1 / CSA FT1 / IEC 60332-1, IEC 60332-2-2
Nominal voltage	300 V AC
Test voltage	2500 V AC
Current load capacity	to DIN VDE 0298-4
Temperature range (fixed)	-40...+80 °C, (+90 °C at max. 10 000 operating hours)
Temperature range (mobile)	-25...+80 °C, (+90 °C at max. 10 000 operating hours)
Bend radius (fixed)	5× outer Ø
Bend radius (moving)	10× outer Ø
No. of bending cycles (C-track)	max. 10 Mio. (25 °C)
Travel speed (C-track)	max. 3 m/s
Acceleration (C-track)	max. 10 m/s ²
Torsion stress	±180°/m
No. of torsion cycles	max. 2 Mio. (25 °C)
Torsion speed	35 cycles/min
Jacket Color	yellow
Technical Data	
Operating voltage	24 V DC ±25%

Rated surge voltage	0.8 kV
Operating current per contact	max. 4 A
Locking of ports	M3/M12×1 mm (recommended torque 0.4/0.6 Nm)
Housing	Black plastic (gray on request)
Protection	IP67 inserted and tightened (EN 60529)

General data

Temperature range	-25...+85 °C, depending on cable quality
-------------------	--

Commercial data

country of origin	CZ
customs tariff number	85444290
EAN	4048879150910
eClass	27279218
Packaging unit	1

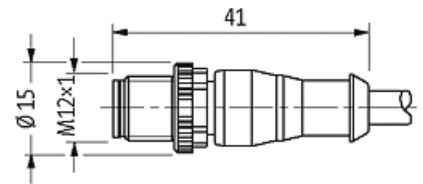
Sketch

Product may differ from Image